



**INNOVATIVE WASTE REDUCTION & RECYCLING GRANT IG8-06
MRFing Our Way to Diversion: Capturing the Commercial Waste Stream**

**MATERIALS RECOVERY FACILITY
TECHNOLOGY REVIEW**

September 2009



Prepared for:

Pinellas County
Department of Solid Waste Operations
3095 114th Avenue North
St. Petersburg, FL 33716

Submitted by:

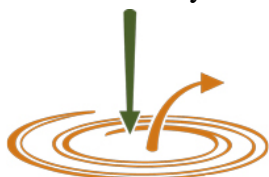

Kessler Consulting, Inc.
innovative waste solutions
14620 N. Nebraska Ave., Bldg. D
Tampa, FL 33613
813-971-8333

Printed on recycled paper



PINELLAS COUNTY, FLORIDA
INNOVATIVE WASTE REDUCTION & RECYCLING GRANT IG8-06
MRFing Our Way to Diversion: Capturing the Commercial Waste Stream

MATERIALS RECOVERY FACILITY
TECHNOLOGY REVIEW

September 2009

TABLE OF CONTENTS

<u>Section</u>	<u>Page</u>
1 Introduction	1
1.1 Background	1
1.2 Methodology	1
2 Overview of MRF Technology and Equipment	3
2.1 Key Objectives of MRF Design	3
2.2 Types of MRFs	3
2.3 Standard Equipment and System Configurations	5
2.4 Specialized Equipment	10
2.5 Design Examples	13
3 Facility Site Visits	17
3.1 Overview of Site Visits	17
3.2 Single Stream MRFs	20
3.2.1 Orange County, FL	20
3.2.2 Davis Street Station, San Leandro, CA	21
3.2.3 Recycle Central at Pier 96, San Francisco, CA	22
3.3 Combined Single Stream and Mixed Waste MRFs	24
3.3.1 Green Waste Recovery, San Jose, CA	24
3.3.2 CVT Regional MRF, Anaheim, CA	27
3.4 Mixed Waste MRFs	28
3.4.1 Athens Services, City of Industry, CA	28
3.4.2 Western Placer Waste Management Authority, Lincoln, CA	29
3.4.3 Sunnyvale SMaRT Station, Sunnyvale, CA	33
3.4.4 Puente Hills, Whittier, CA	34
4 Summary of Findings	37
4.1 Key Developments and Trends in Material Recovery	37
4.1.1 Expanded Target Recyclables	37
4.1.2 Single Stream Recycling	38
4.1.3 Increased Automation	40
4.1.4 Larger Regional MRFs	41

<u>Section</u>	<u>Page</u>
4.1.5 Mixed Waste MRFs	43
4.1.6 Differential Tip Fees	44
4.1.7 Green Building Design	44
4.2 Applicability of Findings	46

<u>Table</u>	
2.1 Comparison of MRF Types in the U.S.	4
3.1 Summary of MRFs Visited	18
4.1 Number of Single Stream MRFs by Geographic Area	38
4.2 Advantages and Disadvantages of Single Stream Recycling	39

<u>Figure</u>	
2.1 Typical Tipping Floor	5
2.2 In-feed Conveyor	6
2.3 Disk Screen	7
2.4 Manual Fiber Sort Line	8
2.5 Material Bunkers	8
2.6 Paper Baler	9
2.7 Bag Breaker	10
2.8 Rotating Trommel Screen	10
2.9 Air Drum Separator	11
2.10 Eddy Current	11
2.11 Optical Sorter	12
2.12 Sample Dual Stream MRF Layout	14
2.13 Flow Diagram of Single Stream MRF	15
3.1 In-feed Conveyor at Orange County MRF	20
3.2 Baled HDPE at Orange County MRF	20
3.3 Incoming Recyclables at Davis Street Station	21
3.4 Davis Street Station Processing Line	21
3.5 Bales of Recovered Paper	22
3.6 San Francisco’s Three-cart System	22
3.7 In-feed Conveyors at Pier 96	23
3.8 Disk Screen at Pier 96 with Top Conveyor Running Above	23
3.9 Baled Mixed Rigid Plastics at Pier 96	23
3.10 Green Waste’s Combined Single Stream/Mixed Waste MRF	24
3.11 Nihot Drum Separator	25
3.12 Materials Exiting Nihot Drum Separator	25
3.13 Demolition Debris Recovery Line at Zanker Road	26
3.14 MSW Composting Bags at Z-Best	26
3.15 Presort Lines at Athens MRF	28
3.16 Vibrating Screen at Athens MRF	29
3.17 Storage Bunkers and In-floor Conveyor to Baler	29
3.18 Trommel Screen at WPWMA	30

<u>Figure</u>	<u>Page</u>
3.19 Disk Screen at WPWMA	30
3.20 Quality Control Following Eddy Current	31
3.21 Recovered ONP at WPWMA	31
3.22 Schematic Diagram of WPWMA MRF	32
3.23 Enclosed Presort Area at Sunnyvale SMaRT Station	33
3.24 Puente Hills Transfer Station with Skylights	34
3.25 Puente Hills MRF Line	35
3.26 Recovered Mixed Rigid Plastics at Puente Hills	35
4.1 Number of Single Stream MRFs in the U.S.	38
4.2 Average Tons Processed per Day	41
4.3 Geographic Areas Serviced by MRFs	42

This page intentionally left blank.

SECTION 1

INTRODUCTION

1.1 Background

Recent efforts by all three Tampa Bay area counties (Pinellas, Hillsborough and Manatee) to promote recycling to businesses and commercial property managers have had limited success. Tampa Bay area recycling coordinators have observed very limited action by private sector recyclers to collect additional volumes of commercial recyclables in a manner that provides convenient and cost-effective alternatives to disposal. A lack of adequate materials processing infrastructure has been a serious impediment to increased recycling (particularly in the commercial sector) in Pinellas County and the Tampa Bay area.

To help address this issue, Pinellas County obtained an Innovative Waste Reduction and Recycling Grant from the Florida Department of Environmental Protection (FDEP) to conduct (1) a technology review of current processing technologies and systems and (2) a feasibility study to evaluate the need for and viability of a local or regional materials recovery facility (MRF). While MRFs can be developed to recover a variety of materials, the focus of this study was MRFs designed primarily to recover and process fiber and containers.

Pinellas County Department of Solid Waste Operations (SWO) retained Kessler Consulting, Inc. (KCI) to assist with both elements of this project. This report presents the results of the technology review; the feasibility study is presented in a companion document.

1.2 Methodology

KCI staff first conducted research regarding current processing technologies, equipment and systems. Section 2 of this report provides an overview of the general types of MRFs and objectives of MRF design, as well as a summary of standard and specialized equipment currently found in processing facilities.

KCI then identified what various industry experts consider state-of-the-art MRFs, and gathered available information about these facilities.¹ Because single stream and mixed waste MRFs typically utilize greater automation and more advanced equipment, many of the MRFs researched fell into these categories. MRFs were identified for potential site visits in order to obtain first-hand information about the processing technologies and equipment they utilize, as well as relevant data about recovery rates and operational efficiencies.

Following review with county staff, KCI conducted site visits to the Orange County MRF in Orlando, Florida and eight MRFs in California. County staff participated in the in-state site visit, but was unable to travel out of state. For the purposes of this study, these site visits focused

¹ State-of-the-art is defined as the highest level of development at this particular time.

primarily on single stream and mixed waste MRFs.² KCI staff also visited several construction and demolition (C&D) debris recovery and organics composting operations because they were integral components in the design and function of highly integrated solid waste management programs that included these MRFs. Section 3 of this report provides brief case studies of all nine MRFs that were visited.

Based on this information, KCI identified developments in MRF technology and trends in processing systems, and considered their applicability in Florida, specifically in Pinellas County and the Tampa Bay area. Section 4 presents a summary of these key developments and trends, and their applicability locally and in Florida.

² The term mixed waste MRF refers to a facility that accepts loads of mixed waste for the purpose of separating and diverting recyclable materials or organics from the waste stream and transferring the remaining waste for disposal.

SECTION 2

OVERVIEW OF MRF TECHNOLOGY AND EQUIPMENT

2.1 Key Objectives of MRF Design

MRFs must be designed to produce clean, consistent, marketable products from heterogeneous materials that contain some level of contamination. Designing, constructing and equipping a new MRF, or redesigning an existing facility, requires an efficient integration of automated technologies and manual labor. When designing a MRF, the following are generally considered some of the key objectives in order to maximize efficiency and cost-effectiveness:

- Maximize material throughput.
- Maximize material recovery and minimize processing residue.
- Maximize automation and minimize manual labor.
- Create a safe environment for workers.
- Produce consistent streams of quality recovered materials.
- Optimize system performance and reduce downtime.

2.2 Types of MRFs

A MRF is a processing facility where materials are sorted and prepared for marketing either to end users (manufacturers) or to other facilities for additional processing. Configuration of the MRF processing line will vary depending upon how materials are received.

- Source separated – Incoming recyclables have been sorted by type at the point of collection, e.g., drop-off and curb-sort collection programs. Some processing might be needed to further sort materials, such as separating steel cans from aluminum cans and sorting glass by color, but the primary purpose of the facility is to remove contaminants and prepare the material for marketing, often by baling, flattening, or crushing.
- Dual stream – Recovered materials are received in two streams, typically fiber (newspaper, magazines and catalogs, mixed paper, cardboard, etc.) and commingled containers (plastic, glass, metal, and sometimes aseptic containers). Separation of materials is accomplished by a combination of automated equipment and manual sorting.
- Single stream – Recovered materials are received in a single stream, with fiber and commingled containers combined. The first stages of processing typically utilize equipment that separates the material into two streams (fiber and containers), which are further sorted using equipment similar to that used in dual stream MRFs.
- Mixed waste – Unsegregated mixed waste is processed using various technologies to separate mixed recyclable materials from waste. Recyclable materials are then processed using equipment similar to a single stream MRF. Some mixed waste MRFs process the

entire waste stream, while others target commercial waste or loads rich in recyclables. Most try to minimize the amount of wet or organic waste being processed.

With advancements in automated processing equipment, less upfront separation is required. For example, many source separated MRFs gave way to dual stream MRFs, which in turn are being replaced by single stream MRFs in some locations. Technological advancements in processing mixed waste have enabled improvements at what were once known as “dirty MRFs.” As some communities are striving to achieve waste diversion rates of 50% or higher, they are recognizing the critical role one or more of these types of facilities will play in their overall waste management system. The existence of a single stream MRF might not preclude the utility of a mixed waste MRF to capture additional recyclables that remain in the waste stream.

While no two MRFs are exactly alike, Table 2.1 summarizes some of the key differences between dual stream, single stream and mixed waste MRFs.

Table 2.1: Comparison of MRF Types in the U.S.³

System Aspect	Dual Stream	Single Stream	Mixed Waste ⁴
Typical incoming material stream	Commingled containers and mixed fibers in separate streams	Commingled containers and mixed fibers in one stream; glass may be separate	Recyclables mixed with non-recyclables, preferably with organics and wet waste removed
% of current MRF systems	52%	33%	<5%
Average residue levels	With glass: 6.79% Without glass: 5.84%	With glass: 11.71% Without glass: 8.10%	Range: 25-75%
Average throughput per processing line	137 tons/day	206 tons/day	400-2,400 tons of MSW/day
Specialized equipment	Standard MRF equipment	Inclined disk screens to separate fiber from containers; polishing screen	Bag breaker; drum separator, trommel and/or vibrating screen to separate recyclables from MSW
Final product quality	Typically high with minimal contamination	Increased risk of cross contamination between containers and fiber	Variable depending on feedstock and processing line
Average facility size (square feet)	10,000 – 50,000	50,000 – 150,000	50,000 – 200,000
Average capital cost (2006\$)	\$4,907,000	\$7,551,000	\$3-11 million for equipment alone (2009\$) ⁵
Average capital cost/daily ton (2006\$)	\$106,690	\$66,630	n/a

³ Dual Stream and Single Stream information is based on Eileen Brettler Berenyi, *Materials Recycling and Processing in the United States: 2007-2008 Yearbook and Directory* (Connecticut: Governmental Advisory Associates, Inc., 2007), 15-36.

⁴ Based primarily on site visits to six mixed waste MRFs in California.

⁵ Based on information provided by MRF design firm. Varies based on facility size, level of technology, target materials, and other factors.

2.3 Standard Equipment and System Configurations

The configuration of a MRF processing line is critical to the overall quality of the materials marketed. It depends upon numerous factors including the types and quantities of materials to be processed, desired processing rates, and required specifications for the end products. While no two MRFs are identical, they generally employ common design principles and sequencing in the configuration of equipment and labor.

MRFs are designed in three dimensional space, taking advantage of height to facilitate materials handling and storage as well as minimize the facility footprint. As a general rule, incoming materials are elevated by conveyor belts to above-ground platforms where equipment and personnel separate out materials, which then fall into or are conveyed to interim storage bunkers. Recyclables are then processed (i.e. baled, densified, etc.) and placed into storage prior to being transported to markets. The major processing steps in a typical single stream or dual stream MRF are described in the following paragraphs.

Step #1: Recyclables Dumped on Tipping Floor

As shown in Figure 2.1, recyclables are first offloaded on a tipping floor inside the MRF and stored until processed. Commonly, the tipping floor is sized to provide at least two days of incoming storage capacity to allow a buffer against unscheduled equipment downtime, to provide sufficient material for the MRF to operate during a second shift, and/or to accommodate future growth. The floor is constructed from concrete able to withstand heavy traffic and impacts.



Figure 2.1: Typical Tipping Floor

Material receiving and storage areas are typically housed in covered structures to keep materials dry and to avoid leachate runoff. Tipping floors need multiple, large access doors and sufficient area so vehicle delays are minimized and incoming loads can be tipped directly on the concrete slab. Special considerations may also be required if bulk (transfer trailer) loads of recyclables are to be received. Tipping floors also need high concrete push walls to protect the building structure and facilitate materials handling and storage. Bucket loaders are used for materials handling. A trained loader operator typically manages incoming traffic and inspects incoming loads for excessive levels of contamination. Laborers may be present to assist the floor manager and to perform “floor sorting” of oversized materials (e.g. cardboard) and large contaminants.

Step #2: Materials Delivered to Sorting Line via In-feed Conveyors

A bucket loader pushes recyclables onto in-feed conveyors to move the recyclables into the sorting system. A horizontal conveyor is typically placed below grade so that recyclables can be slid onto the conveyor (see Figure 2.2). For dual stream MRFs, separate in-feed conveyors are dedicated to commingled containers and fiber. In single stream MRFs, both containers and fibers are pushed onto the same in-feed conveyor. The horizontal conveyor connects to an incline conveyor that runs at a slightly faster speed to spread out the material.

Materials should be fed into the sorting system at a consistent flow rate. Metering or leveling drum feeders are often used to accomplish this. A consistent material feed rate prevents surges, allows for more efficient manual sorting in the presort area, and maximizes the efficiency of automated equipment encountered later in the processing line.



Figure 2.2: In-feed Conveyor

Step #3: Presort

The in-feed conveyor typically delivers material to a presort conveyor line where large contaminants, bulky recyclables, and items that could damage downstream sorting equipment or pose a threat to personnel are removed. Recyclables that might be removed at this stage include corrugated cardboard, telephone directories, or large stacks of paper. Sorters stand at work stations alongside a horizontal conveyor belt and inspect material as it passes by. Contaminants or bulky recyclables are dropped through chutes into roll-off containers or waste storage bunkers below the sorting system. Some MRFs have a top conveyor at this stage where telephone directories or large stacks of paper are placed and conveyed for final cleanup and baling.

Step #4: Separating Single Stream Fiber and Containers

Historically, MRF design and technology was based on sorting fiber and containers on separate sorting lines because of their fundamentally different characteristics (shape, size, density, etc.). For example, steel cans are more efficiently captured by a magnet when they are not buried below large pieces of newspaper. Therefore, the evolution into single stream processing has entailed placing specialized sorting equipment at the front of the sorting system that separates fiber from containers, which then proceed on separate sorting lines.

The fundamental technology employed in most single stream MRFs to make this separation is disk or star screens (see Figure 2.3). A disk screen consists of a series of rotating axles, each containing a number of disks spaced along the axle. The disks are intermeshed in arranged rows and decks to form a moving bed. The disks can be round, oval, or star shaped and can be of

varying dimensions and diameters. The disks, as well as the space between the axles, can be adjusted to sort varying sizes of material. Nearly two-thirds of single stream lines in the U.S. are using screening technology.⁶

Large materials travel across the top of the screen while small materials fall through it. To separate fiber and containers, most MRFs utilize inclined disk screens. Fiber, which tends to be flat, travels up the inclined screen and onto the fiber sorting line. Containers tumble back down or through the screen and are then conveyed to the container sorting line.



Figure 2.3: Disk Screen

A series of disk screens are often used to recover various grades of paper. A primary disk screen is typically used to separate cardboard. The technology reportedly can remove 80-90% of the OCC.⁷ An inclined disk screen with smaller disks can also be used to sort other grades of paper such as ONP from smaller paper fractions.⁸ A second stage screen, called a polishing screen, can then separate the remaining smaller paper (mixed paper), containers and residual materials.

Step #5: Sorting Lines

After fiber and commingled containers have been separated into two different streams, they travel down separate sorting lines. These sorting lines employ a combination of positive and negative sorting to recover specific types of recyclable commodities. The lines might utilize some automated equipment, but almost always include manual sorting from conveyor belts.

Fiber: MRFs handling primarily residential recyclables in which the fiber stream is predominantly newspaper and coated groundwood (e.g. magazines and catalogs) might perform a negative sort to produce either a #7 News or Mixed Paper.⁹ The same sorting systems can be used to negatively sort for different recycled paper grades, depending on

Whether by hand or machine, there are two basic sorting methods:

Positive sorting – the targeted material is pulled out of the material mix

Negative sorting – foreign material and impurities are removed and the targeted material remains on the conveyor

⁶ Berenyi, 43.

⁷ Various industry experts, including MRF design firms. OCC is Old Corrugated Cardboard.

⁸ ONP is Old News Print.

⁹ Recycled paper commodities are broadly defined by the Paper Stock Institute. #7 News is a lower quality than #8 News, which must be “free from magazines, white blank, pressroom overages, and paper other than news.”



Figure 2.4: Manual Fiber Sort Line

remove recyclable commodities, while leaving residue and contaminants on the sorting conveyor. Plastic containers may be manually sorted or mechanically separated with disk screens or air classifiers. Further sorting of plastic by resin and color is generally performed manually. Steel cans are removed by a magnetic separator. Aluminum cans may be manually sorted or mechanically recovered using an eddy current separator. Whole glass bottles are typically manually separated, although optical sorting machines are becoming increasingly common. As materials are positively sorted, they are dropped through chutes or transferred to separate conveyors that connect to storage bunkers. In some MRFs, broken glass remains on the conveyor as a negative sort, and then is delivered directly to a bunker at the end of the conveyor.



Figure 2.5: Material Bunkers

feedstock characteristics and market conditions. Positive sorting activities on the fiber line generally entail personnel picking off OCC, ONP and possibly high grade paper (see Figure 2.4). Positively sorted materials are dropped through metal chutes into storage bunkers below. MRFs with high-volume fiber lines generally incorporate a set of sorting stations followed by a “load flipper” that inverts the material on the conveyor to expose buried material before a final series of sorting stations.

Commingled Containers: Container sorting lines

at MRFs generally rely on positive sorting to

Step #6: Interim Storage

Sorting and processing functions at a MRF need to operate independently. For example, it is more efficient for a MRF to operate a single, high-capacity baler to handle all different grades of paper. Likewise, another baler may be configured to handle steel, aluminum and various types of plastic containers. Consequently, MRFs employ interim storage bunkers, which are often located directly below or near the sorting line. In most modern MRFs, the bunkers are equipped with their own in-floor conveyor and placed perpendicular along the side of the conveyor. The materials are stored in the bunkers until sufficient quantities have accumulated to be prepared for shipment.

Step #7: Preparing Materials for Market

Consolidating or densifying recyclable commodities is the final step in MRF processing before materials are loaded into vehicles or rail cars for shipment to market. This step increases onsite storage capacity and improves transportation efficiency. The most widely used processing method in modern MRFs is to compress material into large, dense rectangular cubes called bales, the size of which can be adjusted. Baling equipment (balers) are classified as either horizontal or vertical (also called down-stroke), depending on the direction that the primary compression ram travels. Horizontal balers handle higher capacity throughput than vertical balers and are the most common balers used in MRF operations.



Figure 2.6: Paper Baler

Horizontal balers are classified based on two main features. First, the baling chamber can be either open or closed. Second, balers may be single-ram or two-ram, which describes the number of hydraulic compression rams employed. Figure 2.6 shows an open-chamber single-ram baler. Compression pressure and bale density is controlled by the metal arms that squeeze the bale as it is discharged.

A single-ram baler can be adjusted to produce bales of various lengths, but cannot produce a bale as densely compressed as a two-ram baler. A two-ram baler produces only one size of bale, but can switch quickly and easily to process different types of materials. Two-ram closed-chamber balers use one ram to compress materials into a closed chamber, and then a second ram mounted perpendicular to the first one to discharge bales from the chamber.

Balers used for paper are usually equipped with a fluffer that partially chops and fluffs up the paper as it falls into the baling chamber, which helps improve bale consistency and quality. Balers used for plastic bottles are sometimes equipped with a perforator that punctures and flattens them as they fall into the baling chamber. This helps to reduce plastic bottle “memory” – or the tendency for them to expand after baling.

Balers are widely used to process the full range of MRF commodities with the exception of glass. Glass crushers are used to produce material with consistent particle size, and are available in various throughput capacities and cullet (crushed glass) sizes. Some MRFs employ other equipment to handle cans and plastic bottles. For example, can flatteners and densifiers are sometimes used for steel and aluminum cans and are available in various throughput capacities. Shredders and granulators are occasionally used in MRFs for plastic bottles, but are more commonly used by secondary processors that receive baled plastics from MRFs.

2.4 Specialized Equipment

Two major trends in recycling collection have been (1) to improve collection efficiency by increasing the level of commingling and (2) to increase the number of materials collected (e.g. all residential paper and all plastic containers). In order to handle increased commingling and diversity of recycled materials, as well as improve efficiency, MRFs employ a range of specialized and automated technologies. Mixed waste MRFs in particular utilize specialized equipment near the front end of the processing line to separate potentially recyclable materials from the remainder of the waste stream.

This section highlights some of the more specialized types of equipment that are used in mixed waste MRFs, as well as equipment that can reduce the level of manual sorting in dual or single stream MRFs. Automated separation equipment can process a larger volume of materials at greater speed than manual sorting. In highly automated MRFs, mixed streams of containers and fibers proceed through task-specific equipment in sequence (the line configuration) to be sorted and separated by size and shape, by weight, by electromagnetic characteristics, and by color and chemical makeup. While manual sorting is still the most effective method for certain tasks, such as removing bulky items and conducting final quality control, specialized equipment has reduced labor inputs and contributed significantly to cost savings at MRFs.

Bag Breaker – Bag breakers (see Figure 2.7) are especially useful in mixed waste MRFs where waste is more likely to arrive in garbage bags. Automated bag breakers eliminate the need for manual bag opening. Large, rotating drums open the bags and release the contents, which are discharged from the machine. Rather than send the entire waste stream through the bag breaker, bagged materials are often pulled from the processing line in the presort area and sent through the bag breaker. Released materials then rejoin the processing line.



Figure 2.7: Bag Breaker

Rotating Trommel – Rotating trommels are used to separate materials by size (see Figure 2.8). A trommel screen is a perforated, rotating drum set at an angle to allow for gravity feed and discharge. The rotation creates a tumbling that separates out smaller-sized objects (e.g. dirt, grit, bottle caps and broken glass) that fall through the perforations. Larger objects work their way through the drum to exit at the downstream end. Trommels of different lengths and with varying perforation sizes can be set in a series for staged screening. Trommels typically range from



Figure 2.8: Rotating Trommel Screen

8 to 80 feet in length and from 2 to 6 feet in diameter. Trommels are sometimes used in mixed waste MRFs after the presort area. In some mixed waste facilities, the trommel has small perforations to remove fines (dirt, grit, broken glass, etc.) that are sent for composting. In other mixed waste MRFs, the perforations may be large to make a first cut at sorting paper. Some trommels are equipped with knives to also function as bag breakers, or are enhanced with magnets to simultaneously remove ferrous metals. The rotation and tumbling of materials within the trommel can exacerbate glass breakage. This reduces the ability to recover glass, and also has the potential to contaminate fiber by becoming embedded in it.

Air Classifiers – Air classifiers use blowing air to separate lighter weight materials from heavier materials. For example, the technology can be used to separate aluminum and plastic from glass. The technology can also suck lighter materials from the commingled material stream as it passes by on the conveyor, leaving the heavier material behind. An alternative application employs multiple layers of high velocity air blowing in parallel across the waste stream, taking the lighter materials to another conveyor and leaving heavier materials to drop off the end of the conveyor. The multiple layers of blowing air prevent swirling that would remix materials and is effective to separate materials that differ slightly in weight, such as different grades of paper.

Drum Separators – Drum separators can be combined with other technologies depending on the material targeted for separation. For example electromagnetic drum separators are commonly used for separating ferrous metals. Air drum separators combine one or more rotating drums with a recirculation fan. An example of this technology is the Nihot drum separator (see Figure 2.9), which is in use or being considered by a number of mixed waste MRFs. It uses air separation combined with rotating drums and an expansion chamber to separate materials based on density and shape. The objective is to make an initial separation of mixed recyclables from non-recyclable waste. The recyclable stream continues on through a processing line that is similar in configuration to a single stream MRF. The remaining waste could be further processed to recover organics for composting and the remaining residue would go to disposal.

Eddy Current – Eddy current separators remove nonferrous metals (i.e. aluminum



Figure 2.9: Air Drum Separator

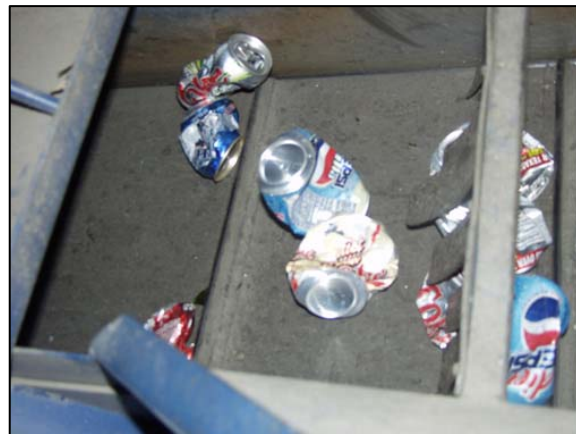

Figure 2.10: Eddy Current

cans) from the commingled container stream (see Figure 2.10). Magnetic rotors spin rapidly to produce a magnetic field and to induce an electric current in the nonferrous metal as it passes by on the conveyor. The electric current in the nonferrous metal generates a magnetic field with opposite polarity to that created by the rotor. The nonferrous metal is repelled away from the rotors by the opposing electrical fields. The eddy current is a mature technology; however, new developments are enabling it to be applied to the separation of aseptic packages from aluminum cans by sensing the thickness of the aluminum in the package. An air classifier then ejects the aseptic package from the waste stream.



Figure 2.11: Optical Sorter

Optical Sorters – Optical sorting machines (see Figure 2.11) incorporate optical sensors with mechanical separators, most commonly small, powerful air jets that blow targeted materials off of a conveyor belt. Optical sorters are able to distinguish not only color differences based on visible light but also distinguish different materials, like plastic resins, based on other optical characteristics. Optical sorters are currently installed in about 14% of single stream MRFs and 7% of commingled container lines in the U.S.¹⁰

Optical sorters are used by glass beneficiation plants to separate glass by color, but are more commonly used to sort plastics in MRFs. The higher market values for plastics, as compared to glass, make the acquisition of an optical sorter more economically viable. Over 70% of the MRFs with optical sorters have units to sort plastics, 17% have units that sort fiber, and 12% have units that sort glass.

Two methods exist to feed material into the optical sensors. A singulated feed presents the objects one by one. This process is relatively slow and not well suited to a commingled recyclables stream. The more commonly used method is the mass feed, which presents a single layer of materials spread across the width of the conveyor belt to the optical sorter. Manufacturers of mass-feed equipment claim sort purities of 90-95%, depending upon the contaminant level of the in-feed and the material being scanned.¹¹ Two sensors can be used in a series to increase the sorting purity or to sort another stream.

A common type of optical sorting equipment used in MRFs today employs Near Infrared (NIR) spectroscopy. By this method, the optical sorter exposes each piece of material to a light source such as a halogen lamp as the material moves past on the conveyor. A microprocessor within the

¹⁰ Berenyi, 42-44.

¹¹ Bob Graham, *A Review of Optical Technology to Sort Plastics & Other Containers* (Environment and Plastics Industry Council and Corporations Supporting Recycling, April 2006), 3.

optical sorter analyzes the quality of reflected light coming off of the material to determine its molecular composition. This unique molecular composition identifies the material for separation.

Glass Cleanup Systems – Single stream and especially mixed waste MRFs generally experience a higher degree of glass breakage than dual stream MRFs. As communities and processing facilities strive to maximize waste diversion, systems are being utilized to clean up or recover glass cullet from shredded fiber, dirt and other debris in the residue stream. Systems can have modular components, such as vibrating screens and air separation, to fit the specific needs of a facility. Unlike glass bottles, which can be used to manufacture new glass bottles, glass cullet is usually marketed for non-container uses, such as construction aggregates, insulation applications, and paving materials.

2.5 Design Examples

No two MRFs are exactly the same; each represents a unique configuration of technologies and systems designed to match the feedstock and meet the needs of the community. However, Figure 2.12 depicts the layout of a typical dual stream MRF and Figure 2.13 presents a flow diagram for a typical single stream MRF.

The dual stream diagram has a configuration and equipment common in many such MRFs, with two distinct sorting lines – one dedicated to commingled containers and the other to fiber. This MRF also has a tipping floor and line for clean loads which is used for processing material from source separated drop-off programs.

The single stream line employs a series of disk screens that are common in such MRFs, as well as automated sorting equipment for commingled containers, such as air classifier, eddy current, magnets and a glass cleanup system.

Figure 2.12: Sample Dual Stream MRF Layout

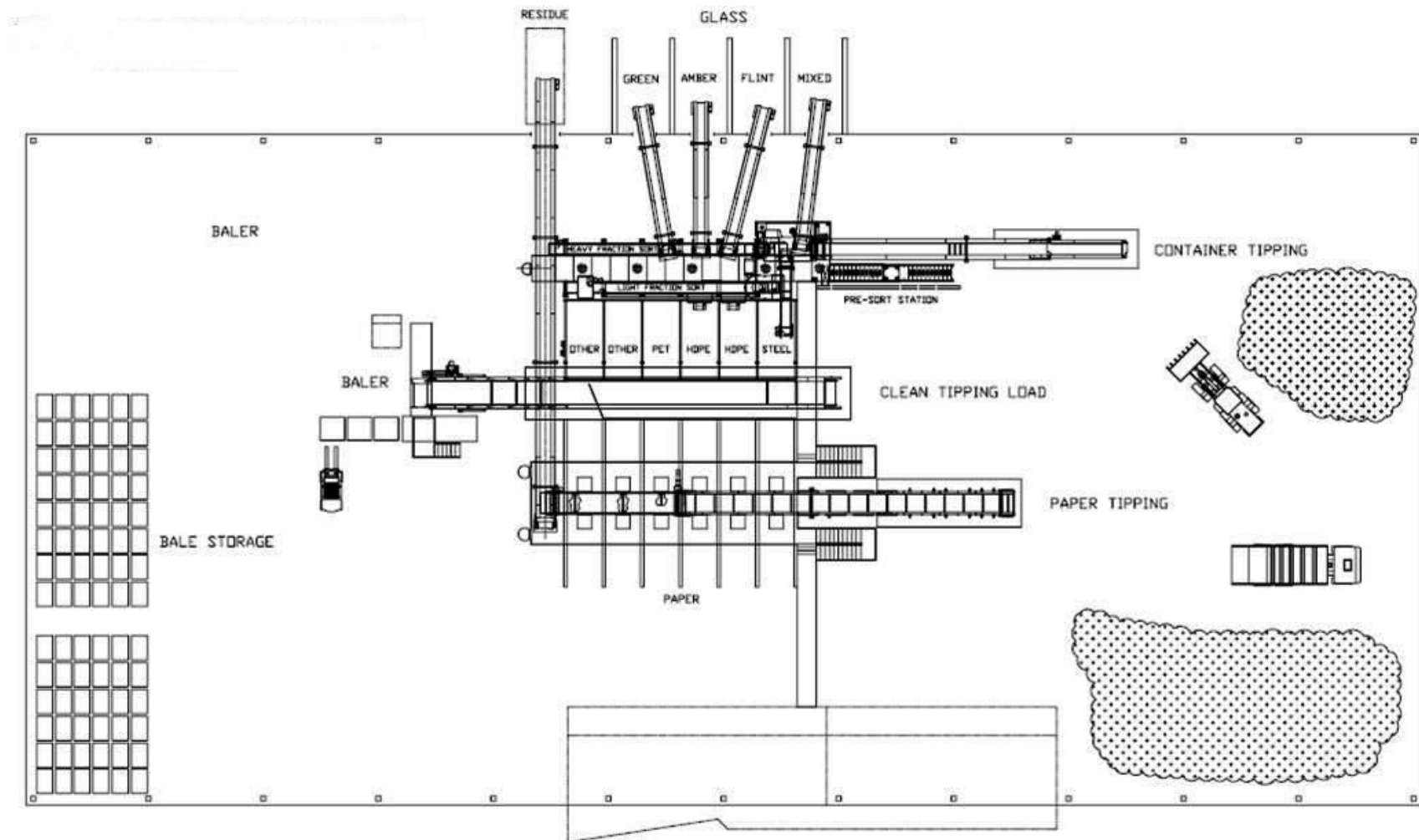
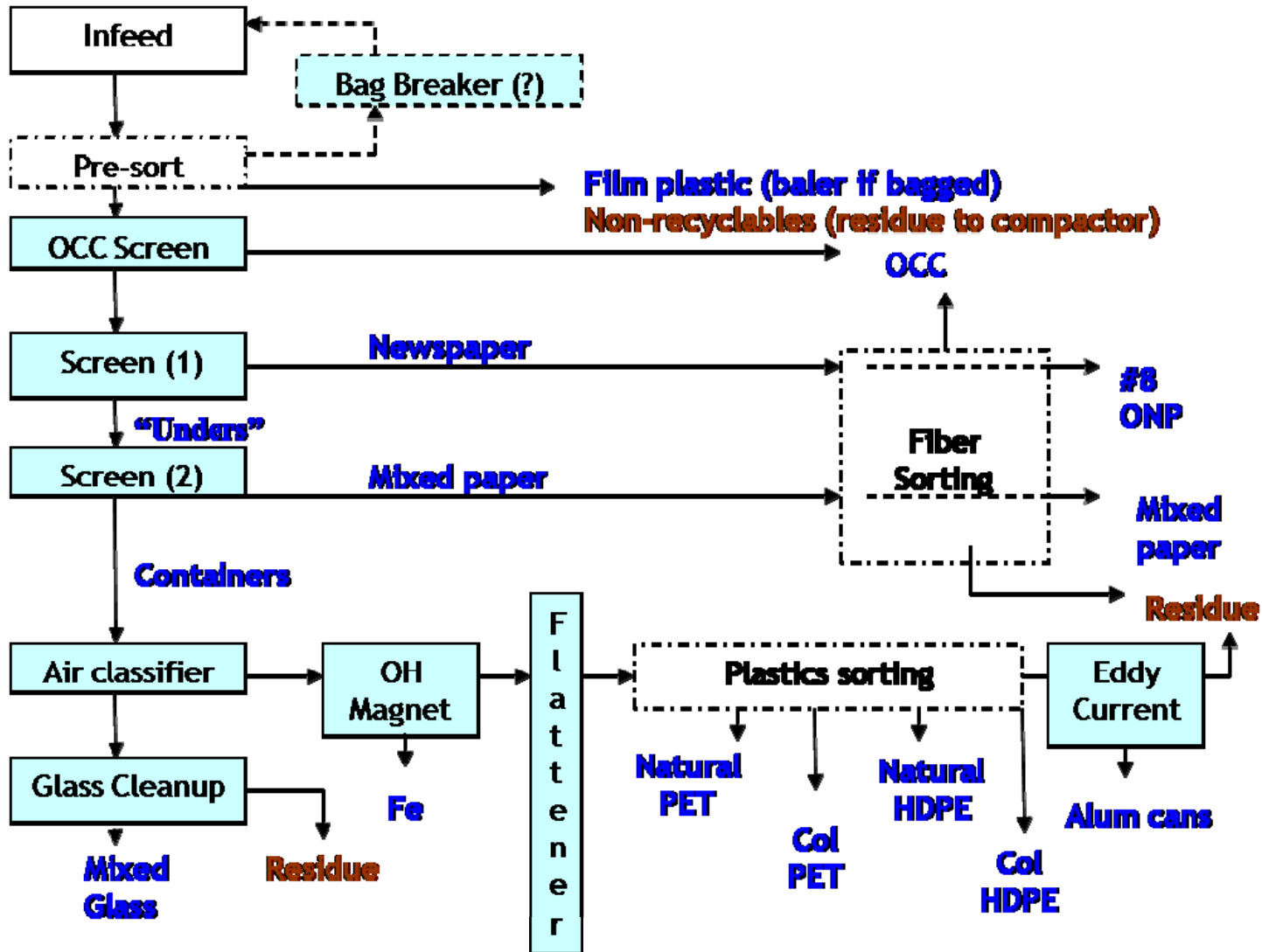

Figure 2.13: Flow Diagram of Single Stream MRF



This page intentionally left blank.

SECTION 3

FACILITY SITE VISITS

3.1 Overview of Site Visits

Following extensive research, KCI recommended two MRFs in Florida and eight MRFs in California for site visits. Both Florida MRFs are single stream facilities operated by Waste Management/Recycle America (WMRA). Because WMRA's Reuters Facility in Broward County was undergoing renovations, it was not available for a site visit. Therefore, KCI and Pinellas County staff members were only able to visit the Orange County MRF on March 25, 2009. On May 4-7, 2009, KCI staff visited the eight MRFs in California; however, county staff was not able to participate in these visits.

These site visits provided useful first-hand information regarding the technologies used at these facilities, collection and processing strategies, recovery rates, and other relevant information. Table 3.1 provides summary information about these facilities. Four of the MRFs are publicly owned and five are private facilities. Three are single stream MRFs, four are mixed waste MRFs, and two have both single stream and mixed waste processing.

All of the California facilities have a variety of recovery, transfer and/or disposal operations taking place at the site in addition to MRF operations. Maximizing waste diversion is clearly a priority. The state of California mandates 50% waste diversion, and a number of local governments have set higher goals of 75% and even Zero Waste. MRF operators cited these state and local mandates as key drivers for their operations. Several private operators have financial incentives in their contracts with local governments to attain specified diversion rates.

The technologies used at the single stream MRFs visited were very similar, whereas the mixed waste MRFs used several different types of equipment to separate waste rich in recyclables from other waste. All facilities reported recovering clean, marketable commodities. Recovery rates for the mixed waste MRFs range from 25-75%. At the facility reporting 75% recovery, about two-thirds of that is achieved through composting and the remainder is recyclables.

The remainder of this section provides brief case studies of each facility. These case studies focus primarily on MRF operations, but summaries of other operations at each site are provided to present a more complete picture of the overall solid waste program. As expected, operators of the publicly owned MRFs were willing to share more information than those at private facilities, and one facility did not allow any photographs to be taken.

Throughout this section, the terms throughput and capacity are used. Throughput refers to the actual quantity of materials processed by a MRF during a given period of time. Capacity refers to the quantity of materials the MRF is capable of processing. Unless otherwise stated, capacity figures usually assume the MRF operates for two shifts per day, which maximizes facility efficiency and cost-effectiveness.

Table 3.1: Summary of MRFs Visited

Facility	Location	Owner	Start-up Date	Throughput (tons/day)	Capacity (tons/day)
Single Stream MRF					
Orange County MRF	Orlando, FL	Orange County	1990; 2005 single stream retrofit	500	650
Davis Street Station	San Leandro, CA	Waste Management/ Recycle America	1996; 2005 upgrade	350	NA
Recycle Central at Pier 96	San Francisco, CA	Recology	2002	700	2,100
Single Stream and Mixed Waste MRF					
CVT MRF	Anaheim, CA	Republic	1991; periodic upgrades	>2,000	6,000 (received at facility, not just MRF)
GreenWaste MRF	San Jose, CA	GreenWaste Recovery	2008	400 MSW; 150 single stream	1,400 (includes green waste & C&D)
Mixed Waste MRF					
Athens Disposal	City of Industry, CA	Athens Disposal	2002	2,400	5,000
Puente Hills MRF	Whittier, CA	Los Angeles County Sanitation Districts	2005	400-500	4,400 (MRF & transfer station)
Sunnyvale SMaRT Station	Sunnyvale, CA	City of Sunnyvale	1994; 2009 retrofit	Not yet operational	1,500
Western Placer Waste Management Authority (WPWMA)	Lincoln, CA	WPWMA	1995; 2006 retrofit	850-1,000	2,000

Table 3.1 (continued): Summary of MRFs Visited

Facility	Materials Processed	Facility Size	Facility Cost	Recovery Rate
Single Stream MRF				
Orange County MRF	Residential & commercial recyclables collected in dual or single stream	NA	\$4M for single stream retrofit	92-94%
Davis Street Station	Residential & commercial single stream recyclables	75,000 sq.ft.	\$1.25M original; \$9M upgrade	88%
Recycle Central at Pier 96	Residential & commercial single stream recyclables	200,000 sq.ft.	\$38M	83%
Single Stream and Mixed Waste MRF				
CVT MRF	Single stream: residential & commercial recyclables Mixed waste: multi-family & commercial waste	210,000 sq.ft.	NA	NA
GreenWaste MRF	Single stream: residential & commercial recyclables Mixed waste: multi-family & commercial waste	95,000 sq.ft.	NA	75%
Mixed Waste MRF				
Athens Disposal	Residential & commercial waste (dry portion of wet/dry collection)	170,000 sq.ft.	\$9M	25-26%
Puente Hills MRF	Select loads of waste received at transfer station that are rich in recyclables	217,000 sq.ft. - MRF & transfer station	\$45M for MRF & transfer station	48%
Sunnyvale SMaRT Station	Residential & commercial waste (complements curbside recycling)	50,000 sq.ft.	\$14.7M retrofit	33-35%
Western Placer Waste Management Authority (WPWMA)	Residential & commercial waste (no curbside recycling)	NA	\$22M original; \$26M retrofit & C&D line	28-30%

3.2 Single Stream MRFs

The three single stream MRFs were similar in configuration, but differed in size. They processed from 350 to 700 tons per day, with Recycle Central at Pier 96 in San Francisco having the capacity to triple its throughput.

3.2.1 Orange County, FL

Owner: Orange County, FL
Operator: Waste Management/Recycle America (WMRA)
Location: 12100 Young Pine Road, Orlando, FL 32829 (adjacent to Orange County Landfill)
Contact: Larry Dalla Betta, Municipal Manager, WMRA
Jimmy Rodriguez, MRF Manager, WMRA

This facility is owned by Orange County, but has been operated by WMRA since it opened in 1990. The county receives a \$7.50 per ton host fee for all recyclables processed at the facility, and a \$3.00 per ton host fee for materials that just pass through the facility (i.e. do not go over the sorting equipment).

Start-up date: Started up as dual stream MRF in 1990. Retrofit for single stream MRF began in 2005.

Number of processing lines: 1

Capacity: 13,000 tons per month. Capable of processing 25 TPH.

Throughput: 8,000-10,000 tons per month.

Diversion rate: Residue of 6-8%.

Material sources: About 80% consists of single stream recyclables from Tampa and Hillsborough and Brevard counties, and 20% consists of dual stream recyclables from Orange and Seminole counties.

FTE: 115 FTE over 3 shifts, with about 25-28 sorters per shift.

Operating hours: Operates nearly 24 hours per day, 260 days per year. Run 2½-3 shifts per day. Third shift is not full 8 hours; may just bale or sort paper.

Processing Line: Bollegraaf/Van Dyk system for single stream.

Cost: Orange County paid \$4 million for single



Figure 3.1: In-feed Conveyor at Orange County MRF



Figure 3.2: Baled HDPE at Orange County MRF

stream retrofit. Future equipment purchases, etc. are to be negotiated between the county and WMRA. Anything that is bolted down becomes the property of Orange County.

3.2.2 Davis Street Station, San Leandro, CA

Owner/Operator: Waste Management/Recycle America (WMRA)
Location: 2615 Davis Street, San Leandro, CA 94577
Contact: Rebecca Jewell
Website: www.stopwaste.org

San Leandro is part of the Alameda County Waste Management Authority, which has a goal of 75% diversion by 2010. Davis Street Station is located on top of a closed landfill. It includes a single stream MRF, C&D recovery operation, green waste (yard waste and food waste) processing, mulch distribution, Ecosite (self-haul), transfer station, and education center.

Single Stream MRF

Start-up date: Fall 1996; new MRF system installed by Machinex in 2005 (operational in fall 2006).

Facility size: 53 acre facility; MRF is 75,000 sq. ft.

Number of processing lines: 2

Throughput: 350 TPD, 85,500 TPY (2006).

Diversion rate: 40% site-wide; 88% at MRF (12% residue at MRF).

Material sources: Hauling districts serviced by WMRA in Alameda County.

FTE: 312 facility-wide; 35 on MRF line per shift.

Operating hours: 1 shift/day processes 40 TPH.

Processing Line: In-feed conveyors, presort, triple deck disk screen. Overs go to paper sort line. Unders go to magnet, vacuum to suction off remaining paper, container sort line, and eddy current.

Cost: \$1.25 million original cost (1996); \$9 million upgrade (2005).



Figure 3.3: Incoming Recyclables at Davis Street Station



Figure 3.4: Davis Street Station Processing Line

Other Operations at Davis Street Station

Transfer station: Waste is transported at night when traffic is less congested.

Green waste: About 550 TPD of yard and food waste is ground and sent offsite for composting (440 TPD) or fuel (70 TPD).

C&D processing line: Reportedly diverts up to 50% of OCC, paper, wood, metal, concrete and plastics from construction sites. Optical sorters have been added to line and are still going through shakedown phase. Facility was not operational during site visit.



Figure 3.5: Bales of Recovered Paper

3.2.3 Recycle Central at Pier 96, San Francisco, CA

Owner/Operator: Recology (100% employee-owned company)

Location: Cargo Way & Jennings Street, San Francisco, CA 94124

Contact: Drew Lehman, Director, Environment & Planning
John Jurinek, Plant Manager, Recycle Central at Pier 96

Website: <http://garbagepit.com/index.htm>

Recology (formerly Norcal) is one of several companies that provide collection and processing services to the city of San Francisco, which has a goal of 75% diversion by 2010 and Zero Waste by 2020. The city provides financial incentives to haulers to achieve these goals. San Francisco has a three-cart system for solid waste, green waste and recyclables. Recology services approximately 333,000 households (population of about 679,000), and also receives some buy-back and source separated materials. Their service fee is \$24.75 per household per month, but this is subsidized by commercial rates.



Figure 3.6: San Francisco's Three-cart System

Recycle Central at Pier 96 is Recology's single stream MRF. The pier is owned by the city with a 25-year lease to Recology. Recology receives and processes other wastes at San Francisco Recycling & Disposal (SFR&D), as further explained below, and also owns 3 landfills. SFR&D receives approximately 2,500 TPD of waste and Pier 96 receives about 700 TPD of recyclables. The two facilities have a combined waste diversion rate of 48% (83% at Pier 96 and 35% at SFR&D).

Single Stream MRF

Start-up date: Fall 2002.

Facility size: 200,000 sq. ft.

Number of processing lines: 4 for curbside materials, 2 for commercial, 1 for commingled containers.

Capacity: 2,100 TPD.

Throughput: About 700 TPD.

Diversion rate: 83% (17% residue).

Material sources: 70% residential/ 30% commercial.

FTE: 180, including 10 managers; employees are unionized. City requires that workers must be hired from a specific geographic area, which is economically disadvantaged.

Operating hours: 2 shifts, plus a maintenance shift.

Processing Line: Designed by Enterprise Company, the residential line consists of the following:

- Conveyor to presort area where OCC, trash, phone books, stacks of paper, and glass are recovered. Presort area has a top conveyor to place phone books and stacks of paper.
- Series of disk screens and polishing screen. Overs (paper) are cleaned and baled. Unders go to container line.
- Residuals are baled and landfilled.
- Cyclone system to recover clamshells.

Cost: Original cost \$38 million (2001).

SFR&D, 501 Tunnel Avenue, San Francisco

Processing operations at SFR&D:

- Urban Recycle Facility – residential drop-off and hand sorting.
- Integrated MRF (I-MRF) – C&D recovery consisting of two lines with shaker screens and manual sorting. Recover metals, concrete, gypsum, wood, etc.
- Organics Annex – food waste processing (little if any yard waste collected in city).
- Household Hazardous Waste Facility.
- Artist in Residence Program and Environmental Education Center.



Figure 3.7: In-feed Conveyors at Pier 96



Figure 3.8: Disk Screen at Pier 96 with Top Conveyor Running Above



Figure 3.9: Baled Mixed Rigid Plastics at Pier 96

3.3 Combined Single Stream and Mixed Waste MRFs

Site visits were made to two facilities that process both single stream recyclables and mixed waste. At Green Waste, the commingled container streams of the two processing systems eventually merge for final sorting. Of the six mixed waste MRFs that were visited, Green Waste reported the highest recovery rate (75%). It is the newest facility and utilizes certain types of equipment that several other mixed waste MRF operators are planning to add to their processing lines.

3.3.1 Green Waste Recovery, San Jose, CA

Owner/Operator: Green Waste Recovery/Zanker Road Resource Management, Ltd.
Location: 625 Charles Street, San Jose, CA
Contacts: Rick Lopez, MRF Manager
Michael Gross, Zanker Road Resource Management

Green Waste/Zanker operates three facilities: (1) Green Waste MRF that processes mixed waste and single stream recyclables as well as limited processing of yard waste and C&D debris; (2) Zanker Road C&D recovery facility/landfill; and (3) Z-Best composting facility.

The City of San Jose has a Zero Waste goal by 2022. The city had an established Pay-As-You-Throw (PAYT) program for curbside recycling, as well as commercial recycling. Despite outreach to multi-family complexes, the city was only able to achieve 18% waste diversion for this sector. With start-up of the new Green Waste MRF in 2008, the city reportedly has reached 75% diversion for this sector and an overall diversion rate of nearly 80%.

Mixed Waste and Single Stream MRF

Start-up date: 2008.

Facility size: 6 acres, 2 MRF buildings total 95,000 sq. ft.

Number of processing lines: 1 line for MSW and 1 line for single stream, which then merge.

Capacity: Permitted for 1,400 TPD total (MSW, recyclables, green waste, C&D).

Throughput: Processes about 400 TPD of MSW and 150 TPD of single stream materials, as well as green waste and C&D. Combined MRF throughput is 47 TPH (25 TPH each on mixed waste and single stream lines).

Diversion rate: 75% (50% to composting and 25% recyclables).

Material sources: Waste and materials collected by Green Waste as well as from Green Team, which used to be a sister company. Single stream line receives residential and commercial recyclables. Mixed waste line receives multi-family and commercial waste.



Figure 3.10: Green Waste's Combined Single Stream/Mixed Waste MRF

FTE: 150 in total facility; 125 in 2 MRFs.

Operating hours: MSW lines run 2 shifts; single stream runs 1 shift.

Processing Lines: Newest and most technologically advanced of the facilities visited. Uses Bulk Handling Systems (BHS) equipment.

Mixed waste line:

- Floor sort to remove bulky, non-recyclable materials.
- Metered walking floor to conveyor.
- Presort to remove yard waste, wood, metals, OCC, oversized waste or waste that might foul up equipment, glass, mixed rigid plastics.
- Bag breaker.
- Trommel - <2" are fines sent to compost.
- Overs go to Nihot (drum separator that utilizes a vacuum to separate three-dimensional containers from other waste).
 - Heavies go to another screen separator then on for composting.
 - Lights go to disk screen to separate paper from containers.
- Overs are primarily paper that goes to sort line and residue to composting.
- Unders are primarily containers that merge with single stream containers and go to sort line.

Single stream line:

- Conveyor to presort as above.
- OCC screen to ONP screen to polishing screen. Overs (paper) are baled or sent to sort lines. Unders (containers) go to sort lines.
- Post-sort – 2-8 post-sorters monitor for quality control.

Merged container line:

- Optical sorter (NRT Multi-Sort) to recover PET.
- Eddy current for aluminum.
- Electromagnetic separators (primary and secondary) for ferrous metals.
- Manual sort line for plastics 2-7.

Green features: Solar City installed a 1,552-panel solar power system, 300 KW-rated, which produces about 408,000 KW hours (enough to supply 1/3 of facility's energy needs).



Figure 3.11: Nihot Drum Separator



Figure 3.12: Materials Exiting Nihot Drum Separator

Other Operations at Green Waste Recovery

Yard waste processing: Oversized material is ground using a trommel, and then materials are transported to Z-Best composting facility.

C&D processing: About 10 workers manually sort on tip floor to recover metal, OCC, wood.

Zanker Road

Diversion rate: 80% (overall facility).

Processing: According to Michael Gross, it is better to keep construction debris separate from demolition debris for processing because of differences in composition. Three recovery operations: (1) demolition recovery at landfill (95% diversion), (2) demolition recovery at C&D facility, and (3) construction and mixed debris recovery at C&D facility (50% diversion).

Fees: Tip fees are based on type of material and level of separation. Most job sites do some level of onsite separation.

Future plans: Plan to build 200,000 sq. ft. facility to process MSW and commercial waste, and to use more automation.



Figure 3.13: Demolition Debris Recovery Line at Zanker Road

Z-Best Composting Facility (did not visit)

Start-up date: MSW composting began in January 2001.

Facility size: 152 acres, 20,000 sq. ft. building to process MSW prior to composting.

Capacity: 1,500 TPD total, including 600 TPD of MSW/food waste.

Throughput: Receives 650-850 TPD of yard waste and 250-350 TPD of MSW.

Material sources: In addition to Green Waste materials, takes MSW from Sunnyvale, Davis Street Station, etc.

Processing: MSW is processed to remove non-compostables, shredded, and injected into 350-foot long bag (CTI system). PVC pipes are introduced into bags for aeration. Compostables remain in bags for 4 months, and are then removed, turned and cured prior to screening. After screening, the material is stockpiled and cured for an additional 4 weeks before final screening. Yard waste is windrowed separately from MSW composting operations.

Markets: Sold 130,000 tons of compost in 2008; yard waste compost represented about 70% of total product marketed. Sell in bulk only, not bagged. MSW compost is used for landscaping and horticulture. Yard waste produces agriculture-certified organics that can be used on food crops.

Fees: Charges \$80/ton to process (versus \$65/ton to landfill).



Figure 3.14: MSW Composting Bags at Z-Best

3.3.2 CVT Regional MRF, Anaheim, CA

Owner/Operator: Republic Services
Location: 1131 Blue Gum Street, Anaheim, CA 92806
Contact: Stuart Lee, General Manager, MRF/Transfer Operations

The facility includes a single stream MRF, mixed waste MRF, green waste chipping, C&D recovery operation, and transfer station. No photographs were allowed.

Start-up date: Started up in 1991, was acquired by Republic from Taormina Industries in 1998, and has been upgraded over time.

Facility size: Located on 35 acres, the MRF is 210,000 sq. ft. and the transfer station is 40,000 sq. ft.

Capacity: Permitted for 6,000 TPD of solid waste, mixed recyclables, and green waste.

Throughput: Currently receives a few thousand tons per day.

Material sources: 50/50 split between residential and commercial.

FTE: Approximately 200, more than half work on sorting line.

Operating hours: Operates 24 hours per day, 7 days per week. Certain hours are for maintenance and cleanup.

Mixed Waste MRF

Material sources: Receives only commercial and multi-family waste.

Number of processing lines: 4

Processing Line: Use magnets, screens and manual sorting.

Future upgrades: Considering a Nihot system (see description on pages 24-25) and optical sorting for fiber and/or glass.

Single Stream MRF

Material sources: Single stream recyclables from contract cities and unincorporated Orange County. Only 1 city is still dual stream, but it is in process of converting. MRF serves approximately 175,000 households.

Processing Line: Primarily a CP Manufacturing line. Starts with presort, then disk screens, air separators, and manual sorting lines.

Other Operations at CVT

C&D MRF: Use a system of magnets, screen, and manual sorting. Recover wood, metal, concrete, OCC. Recovery rate exceeds 25%.

Green Waste: After grinding, organic material is sent to be composted or used as landfill cover. Bags have been a problem.

Transfer Station: Waste flow controls require waste to go to Orange County's landfill located 11 miles away. Tip fee is \$22/ton.

3.4 Mixed Waste MRFs

Site visits were made to four additional mixed waste MRFs. Of the four facilities, one is privately owned and the other three are publicly owned. Although none of these process single stream recyclables, one (Sunnyvale SMaRT Station) has a dual stream processing line for residential recyclables. The Sunnyvale facility was still going through the shakedown phase after a recent upgrade, and was therefore not yet operational. In addition, the Puente Hills MRF was operating only one day per week because of significant reductions in waste flow to the site as a whole, which also encompasses a transfer station and landfill.

The technologies used at these facilities varied. Two use trommel screens and one uses vibrating finger screens to make the initial separation of recyclable-rich waste from other MSW. At the third facility (Puente Hills), only loads identified as being rich in recyclables are sent through the processing line. A commonality among the mixed waste MRFs is a desire to minimize the moisture of the waste processed. One accomplishes this through wet/dry collection, one through differential tip fees for wet waste, and several by targeting specific waste streams, such as commercial waste.

3.4.1 Athens Services, City of Industry, CA

Owner/Operator: Athens Disposal Company
Location: 14048 East Valley Road, City of Industry, CA 91716
Contact: Eric Herbert, President

The facility is a mixed waste MRF with transfer operations. Athens opted for 2-cart collection systems (wet/dry) rather than 3 carts (single stream, green waste, MSW). It saves on collection, but costs more to process. If they receive single stream recyclables, they mix them with MSW.

Start-up date: 2002.

Facility size: 170,000 sq. ft.

Number of processing lines: 3.

Capacity: Permitted for 5,000 TPD of MSW.

Throughput: Currently receives 2,400 TPD of MSW. Lines process 50 TPH. Claims to be largest mixed waste MRF in CA.

Diversion rate: 25-26%. Hopes to increase this to 60% with the addition of the Nihot system, which will recover an additional 14% of fines to compost.

Material sources: Athens Disposal has exclusive franchises with 19 cities, most of which do not have curbside recycling, for collection and processing. Athens also services other communities. Facility receives waste from other sources as well. Residential/commercial split is about 40/60.

FTE: Nearly 300, about 130 on MRF lines.



Figure 3.15: Presort Lines at Athens MRF

Operating hours: 2 shifts.

Processing Line: Currently use Mayfran equipment. Focus has been more on fiber than containers because containers have been harder to capture.

- Load leveler controls burden depth.
- BHS bag opener is an “offline operation” – bags are manually picked off of the line and run through the opener.
- Presort to remove wood, metals, OCC, oversized waste or waste that might foul up equipment.
- Vibrating finger screens (9” and 2”).
- <2” are fines are screened and sent to Athens’ composting plant in the desert.
- <9” and >2” are sent to manual line.
- >9” goes to paper line.
- Residue is transported to 4 area landfills.

Cost: \$9 million startup costs in 2002.

Future upgrades: Considering \$12 million upgrade that will add 2 Nihot systems, switch finger screens to bar screens, as well as other upgrades.



Figure 3.16: Vibrating Screen at Athens MRF



Figure 3.17: Storage Bunkers and In-floor Conveyor to Baler

3.4.2 Western Placer Waste Management Authority, Lincoln, CA

Owner: Western Placer Waste Management Authority (WPWMA) formed in 1978 to build the landfill. It consists of unincorporated Placer County (40% of waste stream), Roseville (40%), Rocklin (10%), and Lincoln (10%). The WPWMA is staffed by county employees.

Operator: Nortech operates all processing and composting facilities and also took over landfill operations in July 2009. WPWMA retains control of the scalehouse and all money exchanges.

Location: 3033 Fiddymont Road, Lincoln, CA

Contacts: Eric Oddo, Senior Civil Engineer, WPWMA

Mike Tilley, Refuse Utility Manager, City of Roseville

The facility includes a mixed waste MRF, composting operation, C&D recovery, citizen drop-off, and landfill. Since recyclables are not collected separately, they have initiated the “1 Big Bin” public education campaign to educate residents that their 90-gallon cart is actually a recycling can because of the MRF. Green wastes (food and yard wastes) are collected separately and composted.

Participating cities entered into agreements with the county in 1978, which lasted until the landfill bonds were paid off. Because the MRF contract was based on the value of commodities, the cities were required to send a consistent waste stream to the facility during the term of the agreement (i.e. they could not initiate curbside recycling). When the landfill bond was paid off, the county and cities renegotiated these agreements. For example, Roseville is now allowed to market materials collected at its drop-offs and segregated loads of commercial OCC.

WPWMA charges variable tip fees to encourage separation materials for processing and to encourage collection service providers to develop dedicated routes for collecting wet waste. This wet waste bypasses the MRF and is sent directly to the landfill, which has improved the operational efficiency of the MRF.

- MSW - \$68/ton.
- Wet MSW - \$38/ton, to encourage separation of wet commercial waste and keep it from entering the MRF.
- C&D - \$46/ton.
- Segregated green waste - \$35/ton.
- Separated OCC - \$0, plus communities can negotiate revenue share with Nortech.

Mixed Waste MRF

Start-up date: MRF started in 1995. The original design was problematic. Food waste clogged the shaker screens. In 2006-2007, a new line was added that doubled capacity (completed October 2007). The original lines continue to operate, but will eventually be upgraded. It was clear that the new lines function more efficiently and recover larger quantities of cleaner commodities.

Facility size: Total site is 320 acres. MRF, composting, and C&D areas combined are 40 acres.

Number of processing lines: Original MRF line has 3 in-feed conveyors and 5 sort lines. New MRF has 2 in-feed conveyors and 8 sort lines.

Capacity: 2,000 TPD to accommodate this high-growth area in the future.

Throughput: 850-1,000 TPD.

Diversion rate: Site-wide diversion rate is 50%. MRF diversion rate is 28-30%, but has performance tested at 37-38%. A large percentage of the diversion comes from C&D, green waste, and sludge, but according to Mr. Oddo, the MRF was a key factor in achieving 50% diversion.



Figure 3.18: Trommel Screen at WPWMA



Figure 3.19: Disk Screen at WPWMA

Material sources: All residential and commercial waste from member communities, which have a combined population of about 270,000. MSW and green wastes are collected in separate 90-gallon carts.

- MSW – 250,000 TPY, all except about 10% (bulky waste, food waste, and sludge) is processed at MRF.
- Green waste (yard waste and food waste) – 50-55,000 TPY.
- C&D – 16-18,000 TPY.

FTE: Nortech has about 240 staff overall, about 80-100 of which work in the MRF.

Operating hours: Currently operating 1 shift per day, but the facility is staffed 24 hours per day. To achieve design capacity, a second shift will be added when needed.

Processing Line: Machinex designed and constructed the retrofit (see Figure 3.22).

- Floor sort and in-feed conveyors (2).
- Presort for bulky waste, contaminants, and bagged waste, which is diverted to a debagger.
- Trommel screen (10”) – overs (paper) go to sort lines in the old facility to be cleaned and baled.
- Unders go to a triple deck disk screen – overs (paper) go to a sort line to be cleaned and baled.
- Unders go to a 12’ wide slanted disk screen – overs (paper) go to a sort line to be cleaned and baled.
- Unders go to container line, which includes magnet, eddy current, and sort line.
- Optical sorter is being tested at the end of 1 paper line. The line is negatively sorted for paper and the optical sorter is being used to remove any remaining contaminants.

Cost: Original MRF cost \$22M. MRF retrofit and C&D line cost \$26M. Some of the old MRF equipment was used in C&D line. All capital costs were paid for with reserves.

O&M: WPWMA has an annual budget of \$20-25 million; about \$10 million (~50% of budget) is for recovery operations (MRF, composting, C&D). Nortech is paid \$31/ton and retains all commodity revenue except revenue for source separated recyclables that it negotiates with individual communities.

Other Facility Operations

Green Waste (yard and food waste): Ground and windrowed.

C&D Recovery: Initial sorting on the ground, and then sent through a line consisting of a conveyor, grinder, trommel and shaker screen.

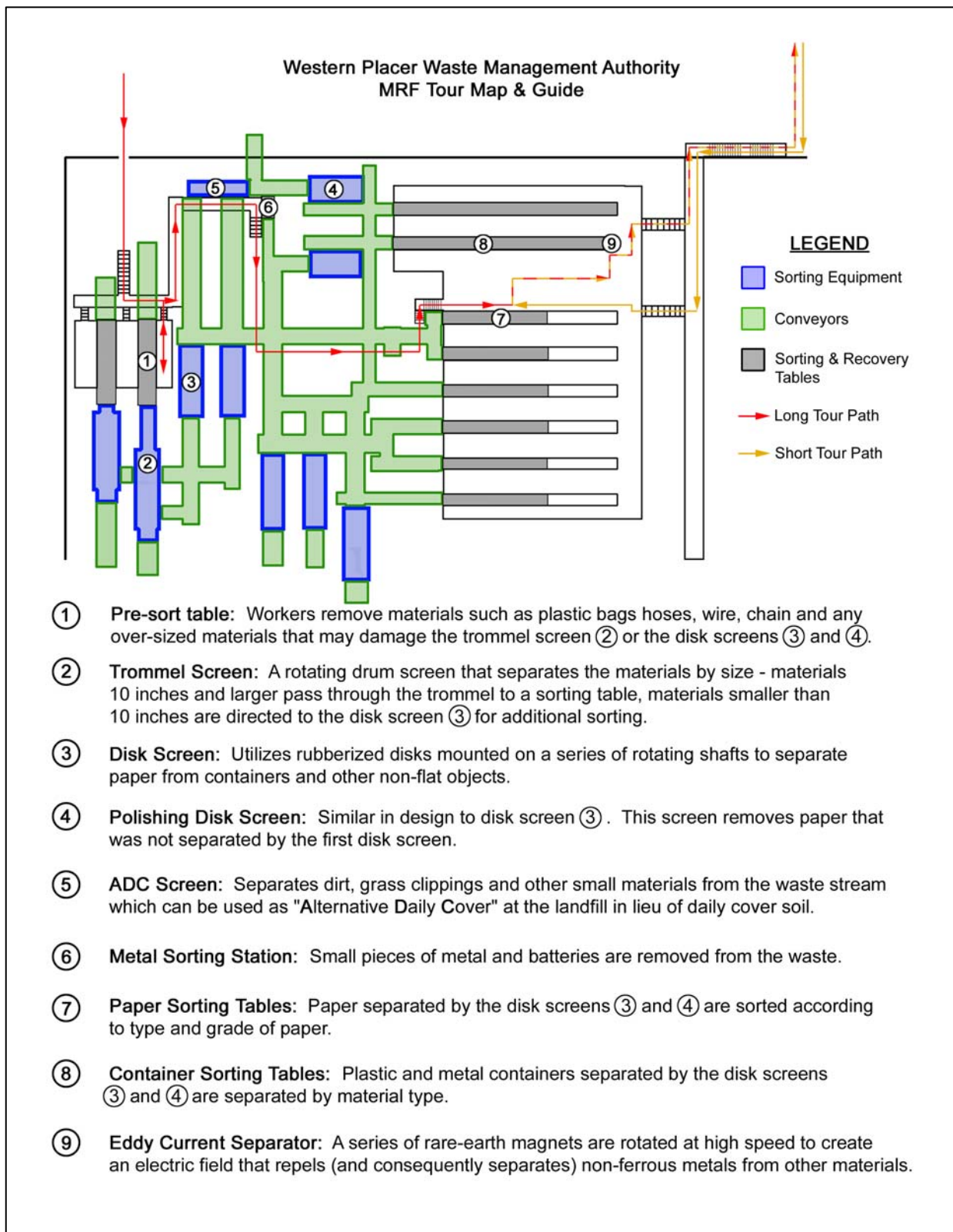

Figure 3.20: Quality Control Following Eddy Current



Figure 3.21: Recovered ONP at WPWMA

Figure 3.22: Schematic Diagram of WPWMA MRF



3.4.3 Sunnyvale SMaRT Station, Sunnyvale, CA

Owner: City of Sunnyvale
Operator: Bay Counties Waste Services
Location: 301 Carl Road, Sunnyvale, CA 94089-1012
Contact: Debi Sargent, Solid Waste Contract Administrator

The facility includes a mixed waste MRF, dual stream MRF, transfer station, yard waste grinding operation, and citizen drop-off. The three cities using the MRF all have dual stream residential curbside recycling programs. The mixed waste MRF was not operational at the time of the site visit. It was in shakedown phase from the recent retrofit.

Start-up date: 1994; 2008 facility retrofit.

Facility size: MRF is 50,000 sq. ft.; transfer station is 50,000 sq. ft.

Number of processing lines: 2.

Capacity: Permitted for 1,500 TPD total.

Throughput: Currently receives about 1,000 TPD of materials, including 800 TPD of MSW. Mixed waste MRF should be capable of processing 50 TPH.

Diversion rate: Old system diverted about 18-22%. Current system is designed for 25% diversion, but can achieve 33-35%. Processing contract is structured to encourage increased diversion. If contractor diverts 25% of MSW, it receives 50% of all material revenue, including revenue for dual stream recyclables.

Material sources: Waste from 3 participating cities – Sunnyvale (55%), Mountain View (24%), and Palo Alto (21%). Most waste will go through MRF unless very wet (i.e. restaurant waste). Curbside recyclables from Sunnyvale and Mountain View are processed at dual stream MRF (Palo Alto's curbside materials are processed elsewhere).

Processing Line: Designed by RRT/URS. Constructed by Monterey Mechanical, which used Krause/CP equipment.

- Enclosed presort area to recover wood, concrete, bulky metals, rejects (carpet, tires, clothing, leather, etc.), OCC.
- Rotating trommels with knives to cut open bags - <2" fines go through magnet and on to composting; >9" go to 2 fiber sort lines; and middlings (2"-9") go to disk screens.
- Overs from disk screens are primarily paper that goes to sort lines.
- Unders are primarily containers that go to magnet and eddy current, then sort line.
- Remaining waste is transported to landfill 27 miles away (tip fee is \$55.34/ton).

Cost: Retrofit cost \$14.7 million with contingencies.



Figure 3.23: Enclosed Presort Area at Sunnyvale SMaRT Station

3.4.4 Puente Hills, Whittier, CA

Owner/Operator: The Sanitation Districts of Los Angeles County, which is a partnership of 24 independent special districts encompassing 78 cities (5.2 million people). The system is comprised of 3 active landfills, 2 recycling centers, and 3 transfer stations/MRFs.

Location: 2808 Workman Mill Road, Whittier, CA 90601

Contact: Matt Zuro, Senior Engineer

The Puente Hills facility includes a transfer station and mixed waste MRF, with a landfill located behind the facility. The transfer station was established as a condition of the landfill extension permit to provide disposal capacity when the landfill closes in 2013. A decision was made to turn the transfer station into a hybrid MRF/transfer station. The Sanitation Districts own and operate a MRF at a different location for processing curbside recyclables.



Figure 3.24: Puente Hills Transfer Station with Skylights

Currently, incoming waste that appears to be rich in recyclables (primarily fiber) is pushed to the side, sorted on the floor to some extent, and then held until the MRF line operates on Wednesdays. Wood waste and carpet are also separated on the tip floor and pushed to the side in piles, and then loaded into transfer trailers and sent for grinding.

All other waste is pushed into transfer trailers and disposed of in the landfill behind the facility. According to Mr. Zuro, this is the second largest landfill in the U.S. The tip fee for either facility is \$39 per ton. The landfill had been receiving near its permitted capacity of 13,200 TPD, but tonnage is down to about 7,500 TPD. Because of the drop in tonnage, the MRF/transfer station was extremely underutilized.

They are currently constructing an intermodal facility across the street from which waste can be rail-hauled to landfills about 200 miles away when the existing landfill closes in 2013. They are currently working on an agreement with Union Pacific Railroad. If agreement is not reached, they will transport with transfer trailers.

Start-up date: July 2005.

Facility size: MRF and transfer station combined are 217,000 sq. ft. MRF alone is 35,000 sq. ft. Entire processing facility is under roof.

Number of processing lines: 1.

Capacity: Permitted for 4,400 TPD of solid waste.

Throughput: Currently receives 400-500 TPD of solid waste.

Diversion rate: In 2008, the MRF line achieved a 48% average diversion rate and the facility as a whole averaged 23% diversion, but it is doubtful these rates are currently being achieved since the MRF is operating only 1 day per week.¹²

Material sources: The Sanitation Districts of Los Angeles County does not provide hauling services and has no flow control authority; therefore, waste flow to the facility is not guaranteed.

FTE: MRF line used to have 25 FTE, but now down to 12.

Operating hours: MRF used to operate 5 days per week, but now operates only 1 day per week.

Processing Line:

- Initial sorting on the tip floor, and then in-feed conveyor.
- Presort line where film plastics and anything that will jam up the equipment are pulled off.
- Disk screen to capture OCC; fines are disposed.
- Mid-sized materials go to manual sorting line where paper, OCC, containers, and film plastics are pulled off.

Cost: \$45 million (2004/05) for the MRF/transfer station, not including the land. Paid for using reserve funds and a construction bond. The bond is being paid off using tip fees. According to Mr. Zuro, tip fees at the landfill subsidize operations at the MRF/transfer station.

Green Building Features: Green features include LNG/CNG fueling facilities, recycled content materials, indoor air quality and climate control systems that meet LEED® requirements, use of reclaimed water, natural lighting, occupancy sensors, and powered by landfill gas.

Future upgrades: Had been considering optical sorting equipment and metering drum for in-feed, but these have been put on hold because of low volumes.



Figure 3.25: Puente Hills MRF Line



Figure 3.26: Recovered Mixed Rigid Plastics at Puente Hills

¹² Lynn Merrill, "A Closer Look at the Puente Hills MRF," *MSW Management*, March 2008.

This page intentionally left blank.

SECTION 4

SUMMARY OF FINDINGS

4.1 Key Developments and Trends in Material Recovery

Based on research and the MRF site visits, KCI identified key developments in MRF design and technologies, as well as trends in material recovery programs. The drivers behind many of these developments are state or local policies for increasing levels of waste diversion and recycling. These requirements, coupled with the robust market demand for recyclables throughout much of the past decade, have resulted in advancements in MRF designs and technologies. The key developments and trends identified by KCI are listed below and further discussed in the following subsections.

- Expanded target recyclables
- Single stream recycling
- Increased automation
- Larger regional MRFs
- Mixed waste MRFs
- Differential tip fees
- Green building design

4.1.1 Expanded Target Recyclables

As communities strive to increase diversion rates, they are targeting more types of materials for recovery. For example, residential collection programs are including additional types of paper. More than 80% of MRFs are processing junk mail, office paper and mixed fiber grades.¹³ Similarly, chipboard and aseptic packaging are now being handled at more facilities.

In Florida, a number of communities are also expanding curbside programs to add plastic bottles #3-7. At most of the California MRFs visited, recycling has expanded even further to include all rigid mixed plastics and plastic film, and viable overseas markets for these materials have been secured.

In locations with higher recycling and waste diversion targets, communities have realized they must look beyond fiber and containers to meet these goals. They are developing fully integrated systems where waste diversion is the primary objective. This was apparent during the California site visits, where nearly all communities had recovery operations for C&D debris, organics (at a minimum including yard and food waste), and various special wastes including electronics, household hazardous waste, and mattresses. Although this project focused on the traditional MRF, it was impossible to ignore the integral role these other recovery operations played in the overall success of these programs.

¹³Berenyi, 18.

As communities and processing facilities strive to “push the envelope” on waste diversion, technological advancements in MRF designs and equipment are encouraged and potential new markets and uses for these materials are sought.

4.1.2 Single Stream Recycling

Single stream recycling has seen tremendous growth in the U.S. over the past five years, as shown in Figure 4.1, and represents at least 30% of all MRFs in the U.S. Lower collection costs, higher material recovery rates, and improvements in the technology to process these materials have helped to spur this growth. This trend began in the late 1990s in the West, but has been spreading eastward, as demonstrated in Table 4.1. Of the 36 facilities in the South, only three are located in Florida.

Figure 4.1: Number of Single Stream MRFs in the U.S.¹⁴

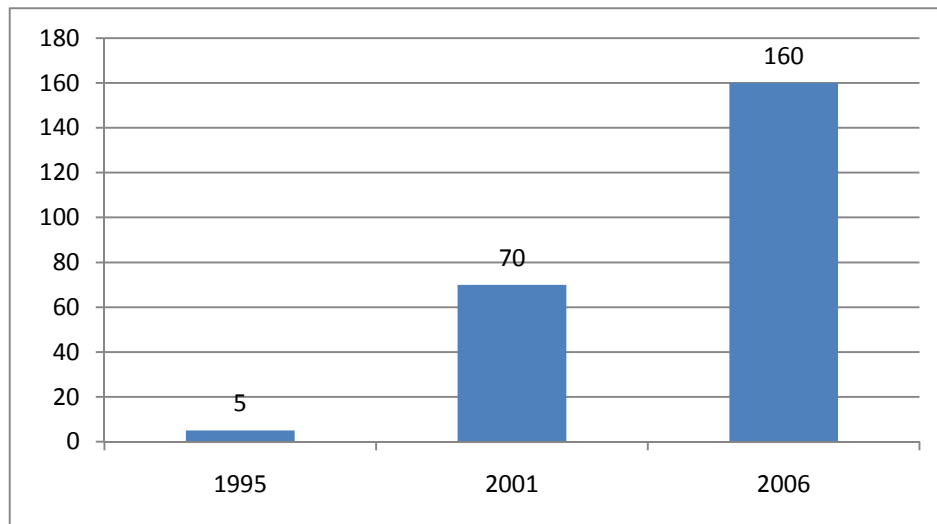

Table 4.1: Number of Single Stream MRFs by Geographic Area¹⁵

Geographic Area of the U.S.	2001	2006
Northeast	0	15
South	20	36
Midwest	9	37
West	41	72
Total	70	160

¹⁴ Berenyi, 33.

¹⁵ Berenyi, 34.

While all single stream programs use one collection container for mixed recyclables, variations exist between programs. Most collect a full range of fiber and containers, while some may eliminate specific materials due to lack of markets or the potential for contamination. The most common material excluded from single stream programs is glass because of the potential for broken glass to contaminate fiber, as well as the relatively low market value for this commodity. Most single stream programs utilize large-volume, wheeled carts (typically 64 to 90 gallons in size) that are collected using fully- or semi-automated trucks. Some continue to use smaller, manually collected recycling bins (typically 14 to 25 gallons in size), usually because per-unit cost is about one-tenth the cost of automated carts.

Most communities that have switched to single stream recycling did so because of collection cost savings and increased convenience to citizens, which in turn increases participation and material recovery. However, single stream recycling requires increased investment in processing to segregate the commingled materials. Table 4.2 summarizes the main advantages and disadvantages of single stream recycling.

Table 4.2: Advantages and Disadvantages of Single Stream Recycling

Advantages	Disadvantages
<ul style="list-style-type: none"> ▪ More convenient for residents and businesses since it eliminates the need to sort materials at the point of generation. ▪ Increased participation as a result of greater convenience. ▪ Greater amounts of recyclables collected, although other program changes also contribute to this. ▪ No specialized (i.e. compartmentalized) collection vehicles needed; vehicle payload capacity can be optimized. ▪ No curb sorting allows more homes to be serviced per route. ▪ Allows for automated collection, which requires smaller labor force and results in fewer worker injuries. ▪ Lower collection costs. ▪ Potential to add more materials to the program, such as plastics #3-7, all types of fiber, and aseptic packaging. ▪ If wheeled carts are used, reduces scavenging and improves community aesthetics. 	<ul style="list-style-type: none"> ▪ Higher MRF capital and operating costs (although cost per ton is typically lower). ▪ Higher container and vehicle capital costs under automated, cart-based system. ▪ Lower per-ton revenue to the local government. ▪ Less quality control at the curb under cart-based system. ▪ Higher percentage of processing residue. ▪ Lower recovery of glass by color. ▪ Potential for lower commodity value if quality control is not maintained. ▪ Potential operational and cost impacts to end users if market specifications are not met.

Measuring the impact of single stream recycling on materials recovery is difficult because the conversion to single stream is usually accompanied by other program changes, such as the addition of other recyclables to the program or the conversion from bin to cart collection. Plus the public education that accompanies any program change usually spikes customer interest and participation, if only for a period of time. Waste Management reports that nationally, the communities they serve reported a 10% to 30% increase in recovery.¹⁶ In Collier County, Florida, Waste Management reported more than a 50% increase in material recovery during the first year after converting to single stream.¹⁷

While the average capital cost of a single stream MRF is \$7.6 million compared to \$4.9 million for a dual stream facility, due to higher per line processing rates, the average capital cost per daily ton is 40% lower for single stream MRFs (\$66,630 versus \$105,690 per daily ton).¹⁸ Most single stream MRFs utilize more sophisticated and costly equipment than dual stream facilities. Nearly two-thirds of the lines in single stream facilities are using screening technology to separate fiber from commingled containers, and then to further separate types of fiber.¹⁹ Approximately 14% of single stream MRFs utilize optical sorters, as compared to only 7% of dual stream facilities.²⁰

Glass continues to be a concern in single stream MRFs. Facilities can institute best practices to keep glass out of the paper and plastic while also maximizing its recyclability. This entails practices to reduce glass breakage until the glass is separated from other material types, such as modifying handling practices on the tip floor and in-feed conveyor and removing glass in the presort. Some of the newest processing systems are designed to break the glass at a very early stage and then remove the glass from the paper.²¹ Such systems typically mean that glass will not be suitable for manufacture of new containers.

4.1.3 Increased Automation

With the reduction in source separation and larger quantities of materials come the need for higher throughputs and more automation. The percentage of highly automated MRFs (i.e. MRFs using computer-assisted technology such as scanners) continues to increase, up 10% in 2006 from 2001.²² Optical sorters are utilized in about 14% of MRF lines, more than a ten-fold increase since 2001, and are now used for plastics, fiber or glass.²³

Many MRFs are intending to either upgrade existing sort lines by adding new conveyors, to further automate lines by adding eddy currents or air classifiers, or to retrofit lines to handle

¹⁶ Jennifer Grzeskowiak, "Choosing to be Single," *Waste Age*, October 2008, 48-52.

¹⁷ Jim Byrd interview, Waste Management Collier County.

¹⁸ Berenyi, 36.

¹⁹ Berenyi, 43.

²⁰ Berenyi, 42-44.

²¹ Susan Kinsella and Richard Gertman, *Single Stream Recycling Best Practices Implementation Guide*, (Conservatree and Environmental Planning Consultants, February 2007), 67.

²² Berenyi, v.

²³ Berenyi, 44.

single stream recyclables.²⁴ This was substantiated by the MRF site visits, during which several operators noted plans for additional automation. Optical sorters and the Nihot drum separator (for mixed waste MRFs) were the most commonly mentioned pieces of equipment.

As automation increases, the need for manual labor decreases and the productivity per sorter increases. The role of manual labor is shifted from sorting lines to various stations on the line to monitor quality control. The manager of one of the newest MRFs that was visited noted that more manual laborers were needed than they had initially anticipated because of the need to be vigilant about quality control.

4.1.4 Larger Regional MRFs

As depicted in Figure 4.2, the average quantity of tons processed per day in MRFs has steadily increased over the past 15 years. Increasingly larger MRFs have been designed and built to achieve economies of scale; to take advantage of more costly, automated processing equipment; to provide regional processing capacity; and to utilize single stream processing technology.

Figure 4.2: Average Tons Processed per Day²⁵

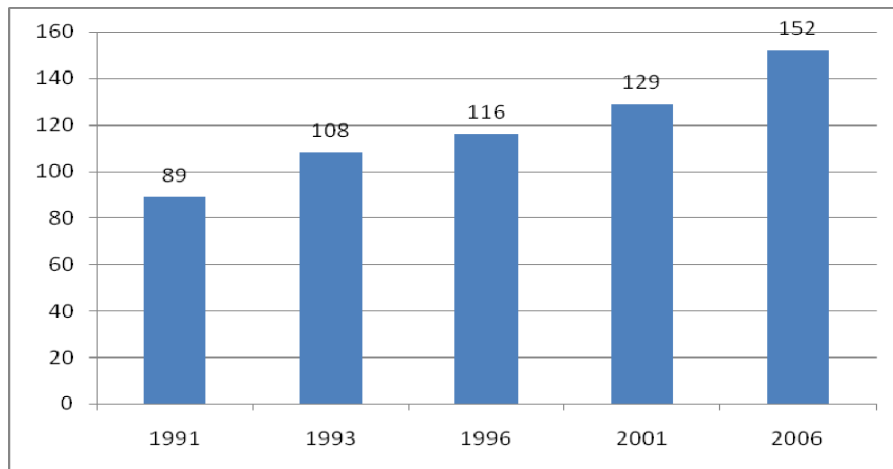

From 2001 to 2006, the percentage of MRFs in the U.S. that processed more than 300 tons per day increased from 7% to 12%. Nearly 40 MRFs have capacity of greater than 100,000 tons per year. Both of the single stream MRFs operated by Waste Management in Florida (Orange County MRF and Reuters MRF in Broward County) are regional MRFs that exceed this capacity. Another example is Palm Beach County's MRF, which processes materials from throughout the county and has a capacity of 98,000 tons per year.

As the average throughput has increased, so has the physical size of the average MRF. Overall, MRFs average 44,100 square feet with a range of about 1,000 to 285,000 square feet.²⁶ The

²⁴ Berenyi, 49.

²⁵ Berenyi, 13.

²⁶ Berenyi, 55.

larger size allows for larger tipping areas, interim storage areas, multiple and flexible processing lines, and automated equipment. Many of the large MRFs are operated by private firms with collection accounts throughout multi-county, or even multi-state, regions.

Large regional MRFs are designed and built to take advantage of capital-intensive automated processing equipment that reduces operating costs. These MRFs draw materials from a large supply area, a trend that mirrors solid waste disposal facilities as well. Curbside recycling trucks do not necessarily deliver materials directly to the MRF. Instead, they may tip at a transfer station which then consolidates recyclables in transfer trailers that can economically haul recyclables over 100 miles to a MRF. Single stream recycling is especially well-suited to such a regional system. The newer automated equipment requires greater capital investment, which in turn requires large processing volumes to economically justify the capital investment. As Figure 4.3 shows, the majority of MRFs now serve multi-city, multi-county or multi-state areas.

Figure 4.3: Geographic Areas Serviced By MRFs²⁷

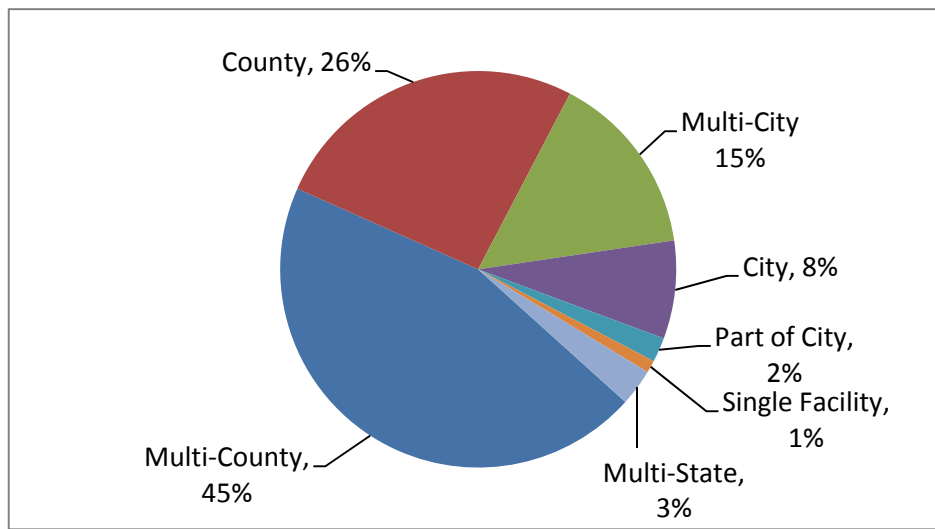

The trend towards increased regionalization of MRFs has also impacted the proportion of privately and publicly owned and operated facilities. More than two-thirds of MRFs are owned and operated by private firms.²⁸ In the early 1990s, public sector ownership and private sector operation of MRFs was common. By 2001, only 15% of projects fell into this category, and by 2006 this percentage had dropped to 12%. Nationwide, about 20% of MRFs are publicly owned and operated, but the South has a slightly higher percentage (25%). It may be difficult for multiple jurisdictions to jointly plan, finance and develop a MRF; whereas a private company can do so more efficiently and offer services to multiple jurisdictions.

²⁷ Berenyi, 69.

²⁸ Berenyi, 60.

4.1.5 Mixed Waste MRFs

Mixed waste MRFs, previously known as “dirty” MRFs, were initially developed in some communities during the early 1990s. They achieved low material recovery rates, had high residual rates, and experienced numerous operational and financial challenges. For these reasons, the method was largely abandoned during the 1990s. In the past five years, a number of factors have combined to reinvigorate efforts to develop and operate mixed waste MRFs, including high energy costs, aggressive waste diversion goals, favorable commodity values, rising tip fees, and technological advancements in separation equipment.

Historically, mixed waste MRFs recovered between 5% and 45% of the incoming material as recyclables with the remainder disposed. The newer mixed waste MRFs that were visited as part of this project reported achieving waste diversion rates of 25-75%. MRFs achieving higher waste diversion rates are recovering a significant percentage of materials in the form of biodegradable material that is sent for composting. One mixed waste MRF operator is also exploring the recovery of high caloric value waste that can be converted to refuse derived fuel.

Mixed waste MRFs combine a number of screening and sorting technologies to separate recyclable materials from non-recyclable residuals. According to the private MRF operators that were interviewed, the most significant technological advancement in mixed waste processing is the Nihot drum separator, which uses a combination of rotating drums and re-circulating air to make this initial separation.

Mixed waste MRFs allow communities to focus on waste streams that are not being tapped using traditional recycling methods, such as multi-family and commercial waste. Some communities are constructing hybrid mixed waste MRF/transfer stations in which loads rich in recyclables are directed to the MRF. Others are sending the entire target sector’s waste through the MRF. While some argue this lacks an important public education element because action is no longer required on the part of the waste generator, it provides another avenue to divert additional recyclables from disposal.

Mixed waste MRFs function more efficiently if putrescibles organics and wet materials are removed from nonorganic, dry materials prior to processing. Wet/dry collection is an emerging strategy for addressing this challenge and has the capacity to dramatically increase diversion. Nationally, only a small number of communities have attempted to implement wet/dry collection programs for residents; however, this was the primary collection system in those communities utilizing the Athens MRF in Los Angeles. Wet/dry systems also are being applied to the commercial sector. In San Jose, for instance, over 500 businesses are on a wet/dry collection route.

The dry fraction in these programs includes source-separated recyclables such as paper and containers, and the wet fraction includes organics, particularly food waste, food-soiled paper, other compostable paper, and other residuals. Advantages of this system include higher recovery rates by individual businesses, convenience to the customer by using two containers instead of three, and the ability to use the same collection fleet for all routes.

4.1.6 Differential Tip Fees

Numerous communities use differential tip fees as an incentive for keeping various waste types separate, with the objective of encouraging recycling participation and/or increasing MRF operational efficiency. Offering lower tip fees can encourage waste generators to separate specific materials or recyclables, or can create an incentive for haulers to establish collection routes for specific types of waste.

Charging lower or no tip fees for recyclable materials has been common practice. As more specialized processing systems are developed to divert more materials from disposal, differential tip fees are being used to encourage other types of waste segregation. For example, some communities charge lower tip fees for segregated loads of C&D debris, which are then sent through recovery systems. Mixed waste MRFs are also using differential tip fee structures to achieve a more processable waste feedstock. For example, Western Placer Waste Management Authority (WPWMA) charges \$68 per ton for mixed waste, \$46 for C&D debris, \$38 for wet commercial waste, \$35 for green waste, and \$0 for source separated OCC. This encourages system users to separate waste into the types of streams the WPWMA system is able to process. Charging a lower tip fee for wet commercial waste than mixed waste has helped improve operational efficiencies at the mixed waste MRF by keeping some of the wet waste out of the facility.

4.1.7 Green Building Design

Awareness of climate change, the need for sustainability, and rising energy prices are fueling a trend in residential and commercial construction to employ “green” building standards in new construction and renovation projects. Increasingly, designers and builders of MRFs are incorporating green building elements in their plans, such as the following:

- Using products made with salvaged or recycled materials.
- Designing to save energy or water.
- Designing to provide a safe, healthy indoor environment.
- Employing techniques that reduce environmental impact during construction.
- Salvaging or recycling materials used during construction.

Shoreline Recycling and Transfer Station in King County, Washington, which opened in February 2008, was awarded LEED^{®29} platinum certification.³⁰ The facility’s green attributes include a rooftop rainwater harvesting system, solar electricity panels, skylights, passive ventilation and recycled-content building components.

The Summit County, Colorado MRF, which was completed in September 2006, is the first MRF to be recognized as a green building by Green Globes, a certifying organization. The 11,000

²⁹ Leadership in Energy and Environmental Design (LEED) Green Building Rating System™ designed by the U.S. Green Building Council (USGBC). Platinum is the highest designation given by the USGBC.

³⁰ Nancy Mann Jackson, “Going Green,” *Waste Age*, November 2008: 30-32.

square-foot, \$1.8 million MRF processes primarily material from drop-off programs. Green building design elements utilized in this facility include the following:³¹

- Two energy recovery ventilators (ERV) that bring fresh air into the building while simultaneously exhausting an equal amount of stale indoor air. (This element had the greatest impact. The hot or cold energy, depending on the season, is extracted from the indoor air before it is exhausted and transferred to the incoming air, so there is little energy lost.)
- Daylight harvesting using south-facing clerestory windows and integrating electrical lighting with daylighting to account for daily and seasonal variations.
- Office flooring made of recycled rubber and recycled soda bottles.
- Low volatile organic compounds (VOC) paint on all interior walls.
- Stormwater runoff controls to prevent damage to the building and vegetation and to minimize runoff into waterways.
- High-efficiency lighting fixtures, lamps, lighting controls/occupancy sensors and HVAC equipment.

Of the facilities that were visited, Green Waste Recovery in San Jose and Puente Hills MRF/Transfer Station in Whittier noted green building features. Green Waste has 1,552 solar panels that produce approximately one-third of the facility's energy needs. Puente Hills employs high efficiency air conditioning systems and lighting, including over 500 skylights. It also uses occupancy sensors to minimize electricity use. Recycled materials were used throughout the project, from the structural steel to bathroom partitions, carpeting, insulation, and ceiling tiles.

Building green increases the number of design decisions for project developers, and understanding the trade-offs associated with each decision can increase cost and time in the planning and design phases. In addition, some green building elements are based on newer technologies and standards may not exist for properly matching and sizing capacities to the actual project. For instance, after the Summit County facility was completed, project developers identified several green elements of the project that were over-engineered, particularly the size and capacity of the ERV system. After conducting a technical audit of the system, the developers concluded that system was oversized by 50%.³²

Meeting green standards can add cost to facility construction. According to one architect, facility costs will increase by about 2% to meet LEED silver certification, 5% to meet gold certification and 8% to achieve platinum certification.³³ Some MRFs have applied LEED principals to assist in designing MRFs, but have chosen not to pursue certification, believing that the costs of auditing and achieving certification are better allocated to implementing green design concepts.

³¹Green Building Initiative, *Case Study: Summit County Material Recovery Facility*, http://www.thegbi.org/assets/case_study/MRFCaseStudy.pdf.

³² Carly Weir, Executive Director, High Country Conservation, and Kevin Berg, Director of Operations, Summit County Solid Waste, interviews.

³³ Doug Brinley, Principal Architect, KPG, Inc., presentation at SWANA WasteCon 2008.

4.2 Applicability of Findings

Florida's proposed 75% recycling goal, established by the 2008 Energy Bill (HB 7135), as well as increased attention to climate change and sustainability, have set the stage for renewed focus on waste diversion and recycling. If the state is to achieve this new goal, or even a statewide rate of 50% recycling, it will need to utilize the material recovery advancements that are found in other locations currently achieving these recycling levels. Investment will be needed in MRF infrastructure to upgrade existing facilities and construct new facilities capable of handling larger quantities of materials and diverting higher percentages of recyclables. Facilities to recover, process and market C&D debris and organics will be necessary. Mixed waste MRFs may need to be considered to capture recyclables from those sectors of the waste stream that are not source separating recyclables.

As seen elsewhere, the initiative and incentive to make these investments will need to be driven by public policies and programs. Without steady public involvement and risk sharing, the private sector will respond to market trends and may stop accepting or processing certain materials when market demand drops. The status of commodity markets and impact on MRF development are discussed further in the *Materials Recovery Facility Feasibility Study*, which is the companion document to this report.

Regarding the applicability of these findings to Pinellas County, the county is currently in the process of establishing countywide residential curbside recycling. An Invitation to Bid is to be released within the next few months and curbside collection is anticipated to begin during the first half of 2010. Currently, the county is planning to solicit bids for both dual stream and single stream collection (both options require using wheeled carts and automation) from residences receiving curbside garbage collection. Initially, the program will not include most multi-family residences or commercial businesses.

A potential and desired outcome of this bid is the establishment of additional private sector processing capacity in Pinellas County or the Tampa Bay area. However, given the current economy and status of commodity markets, it is possible that contractors might transfer recyclables to MRFs outside of the area instead of investing in new or expanded local facilities. If local processing capacity is established, it could provide much-needed processing capacity to support additional multi-family and commercial recycling.

Another unknown factor is the fate of Florida's proposed 75% recycling goal, which is to be achieved by 2020. Key elements of this goal, as they relate to additional MRF development in the Tampa Bay area, include the proposed definition of the use of solid waste to create renewable energy as "recycling," as well as preliminary recommendations by FDEP related to commercial recycling mandates and organics recovery.

The applicability of these findings to Pinellas County and the Tampa Bay area are more fully explored in the *Materials Recovery Facility Feasibility Study*, which is a companion document to this report.